

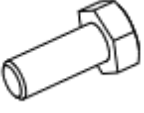







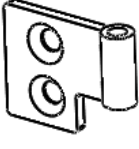

MENTEŞELİ KAPI KURULUMU

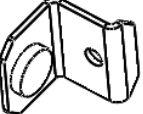
Kapı Bağlantı Seti					
					
M8x15 x8	M8x20 x6	Kulp x1	Menteşe-1 x2	Menteşe-2 x2	İmbus Civata M8x30 x2
					
Mıknatıs Kilit x2	Üst Braket x2	Üst Profil Seti x1	M8x65 x4	M8 x4	

KAPI MONTAJ ADIMLARI

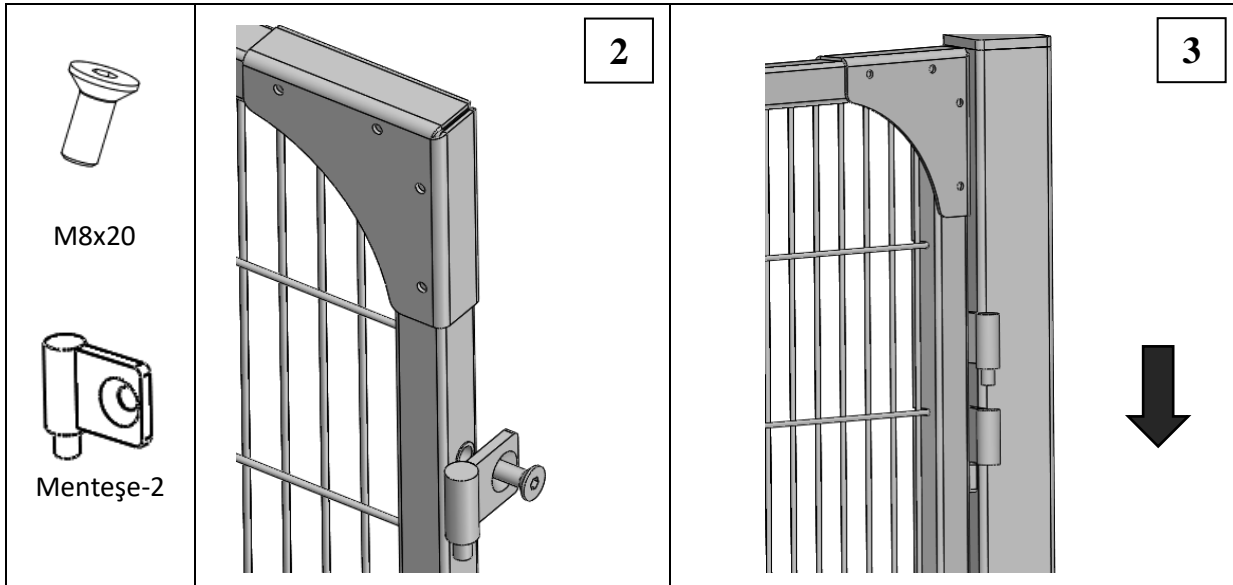
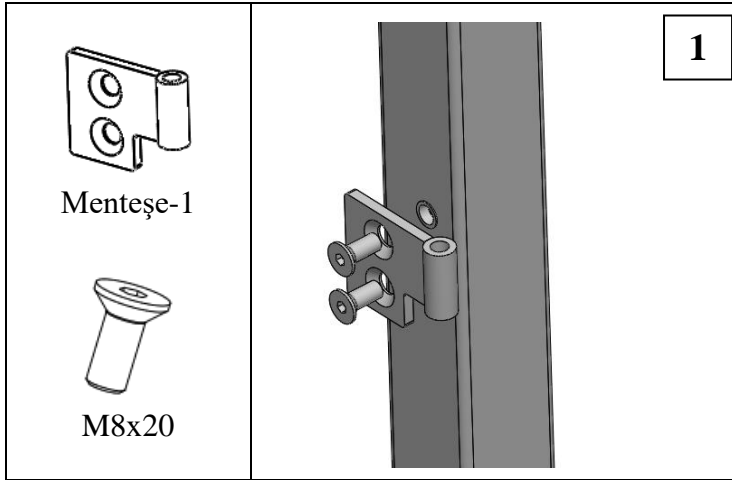

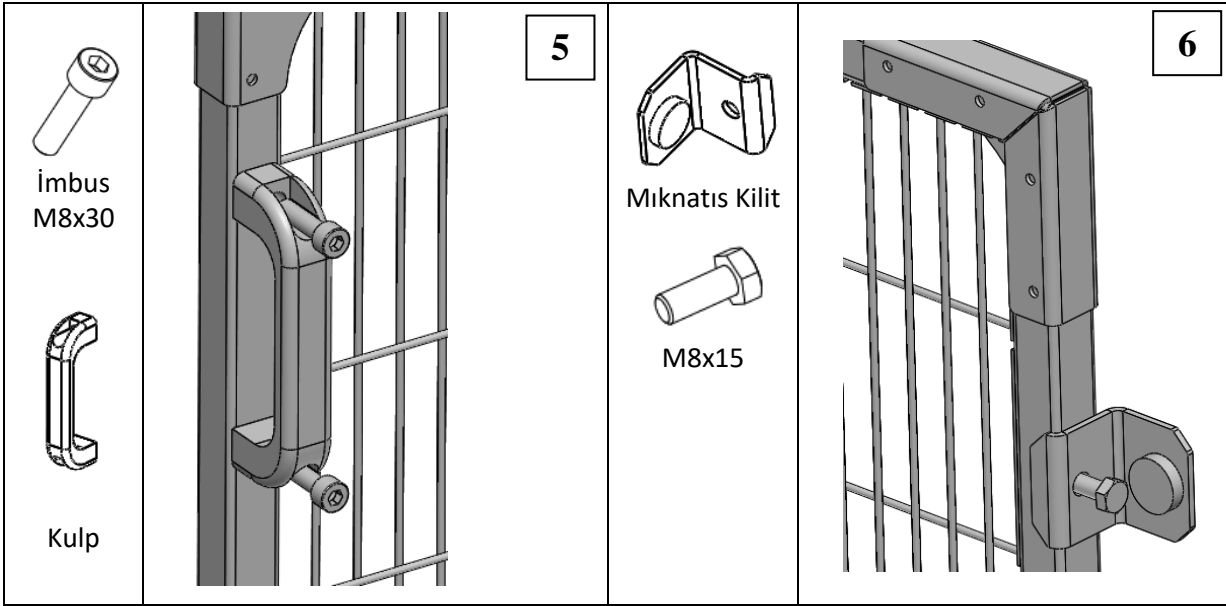
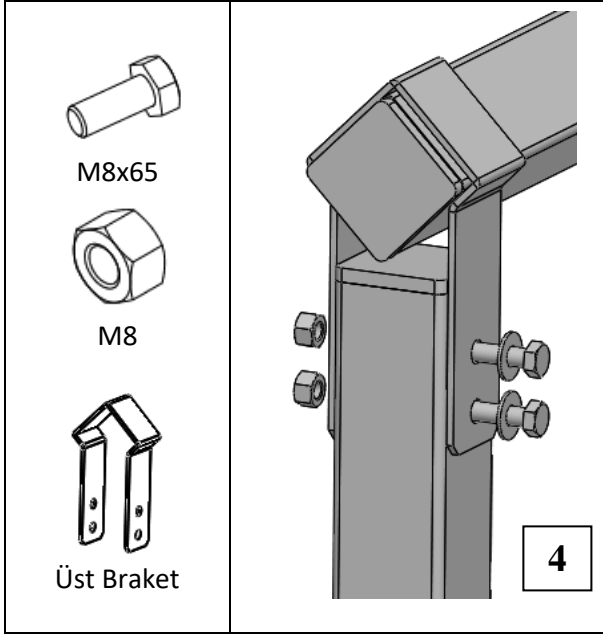

KULLANIM TALİMATLARI

- Kurulum talimatlarına göre montaj yapılmalıdır.
- Dübellerin monte edileceği beton kalitesi en az C20/C25 olmalıdır.
- Boyası zarar gören yüzeylerin korozyona uğramaması için yeniden boyanmalıdır.
- TS EN ISO 14738 normlarına göre panel mesafesi belirlenmelidir.

BAKIM VE İŞLETME TALİMATLARI

- Titreşimli bir alanda sistem kurulu ise en geç 3 ayda bir bağlantı noktaları kontrol edilmelidir.
- Herhangi bir darbe alması durumunda hasar alan parça kontrol edilmesi gecikmeksizin değiştirilmelidir.
- Koruma ekipmanlarına sadece yetkili personel tarafından müdahale edilmelidir.